

Article number: 201581M1230MTE

Description: E+G Screw GN 1581-M12-30-MT-E
EPDM Sealing ring in hygienic design

Measures

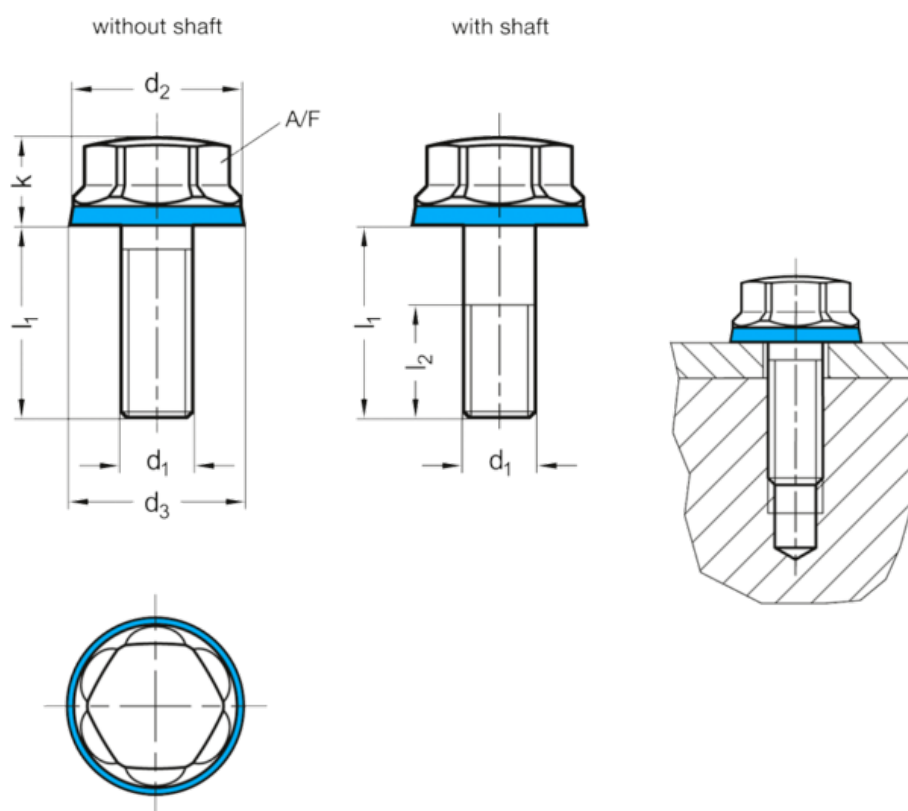

A/F	= 18	Weight in (g) = 50
d1	= M12	
d2	= 22	
d3	= 22.8	
l1 without shaft	= 30	
l1 with shaft	= -	
l2	= -	
k	= 11	